

2004-2008 KUBOTA RTV900 **Standard Winch Mount**

Winch Mount

PART # 100471

Kit Components:

<u>Qty</u>	<u>Part Description</u>
1.....	Replacement Winch Mount Plate
1.....	Winch Mount Fairlead bracket
1.....	Hardware kit (Mini-Rocker Switch)

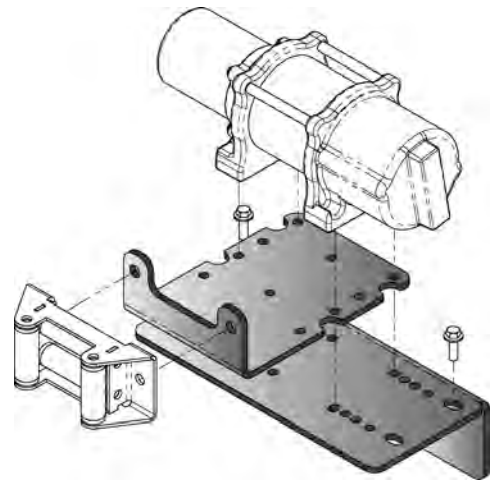

INSTALLATION INSTRUCTIONS:

1. Open hood and open the clear flaps that access the winch pocket.
2. Replace the OEM Plate (A) with the new included winch mount plate by removing the (4) Bolts that hold the plate to the RTV frame as shown in Figure 1.
3. Attach your Roller/Hawse Fairlead to the Fairlead Bracket as shown in the above exploded view using the hardware that was supplied with you Fairlead.
4. Assemble your Winch Wires (longer wires) to the winch .
5. Place your winch into the winch pocket. It is easier to get it into the winch pocket by inserting it in through the engine compartment (see B) Figure 2.
6. Place you assembled fairlead plate between your
7. winch and the mounting plate. You will then need to align the mounting plate, the fairlead plate and the winch using the bolts patterns shown on page 2. (you can align these from under the machine)
8. Assemble your winch to the mounting plate and fairlead plate from under the machine using the hardware included with your winch.
9. Using the instructions provided with your winch, wire accordingly.

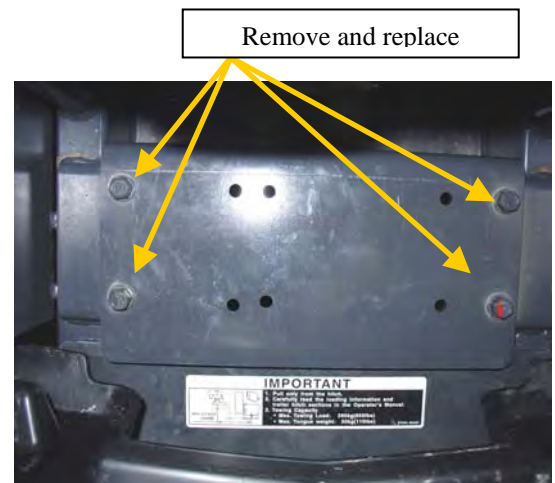

“Figure 1” Replace Mount Plate

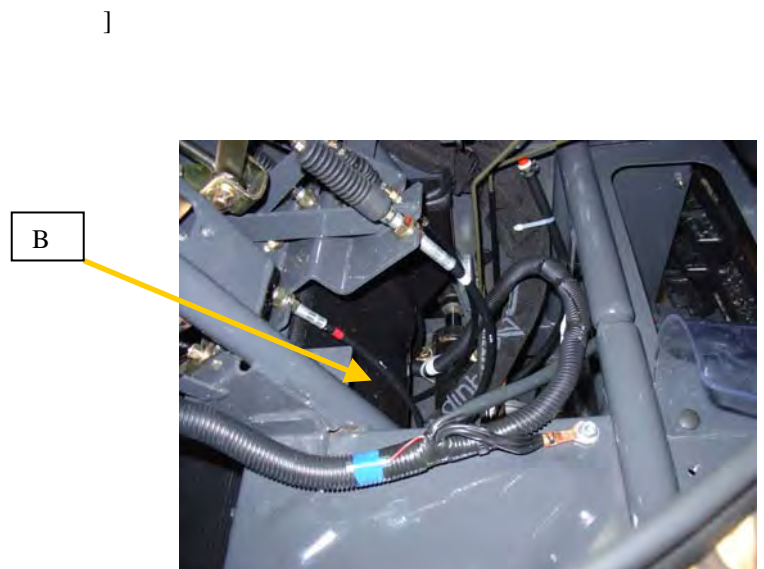

“Figure 2” Place Winch into position

CONTACTOR LOCATION

Contactor location is located under the drivers seat as shown in Figure 3. (Note: You may need to re-drill the contactor mounting holes as there are a few contactors that will not have the same mounting bolt pattern that is on your Kubota)

Mini-Rocker Switch Hardware Kit

This allows you to mount your usual handle bar mounted switch to almost any desired location.

- a. Remove handlebar mount hardware from the switch.
- b. Locate desired mounting location
- c. Mark and drill two switch holes through dash using switch housing as a template
- d. Drill a 3rd hole for the switch wiring.
- e. Assemble per Diagram below

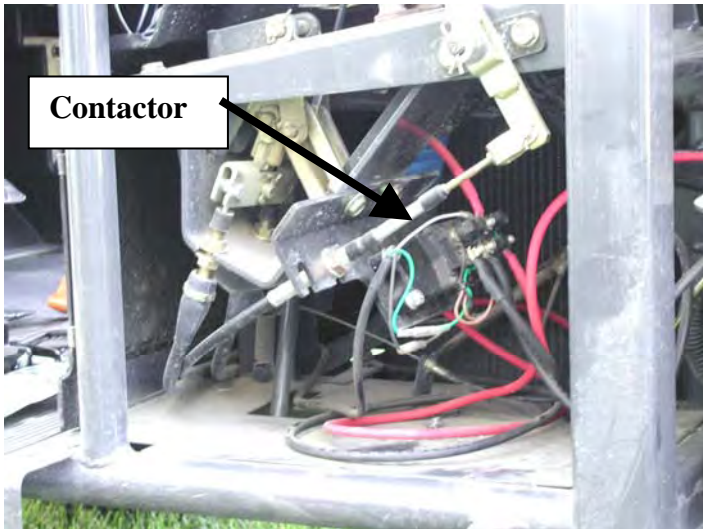

“Figure 3” Contactor Location

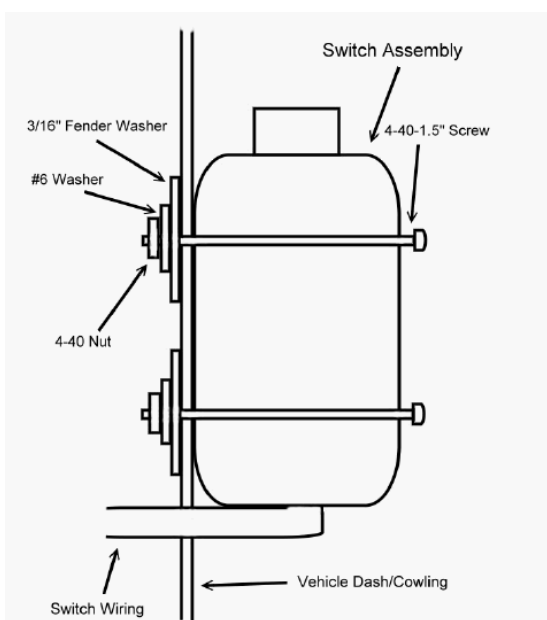

Optional Switch Mount Instructions*



STD 4-HOLE

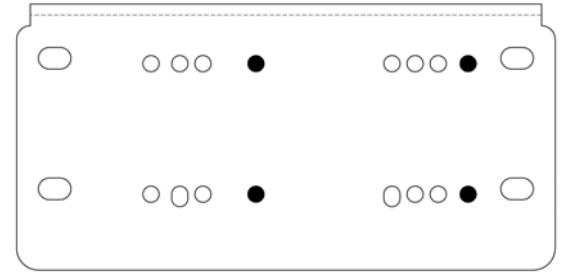

VENOM 2000/2500/3000 HARDCORE SERIES
WARN 2.5
MILE MARKER PE2500

WARN 3.0/RT/XT

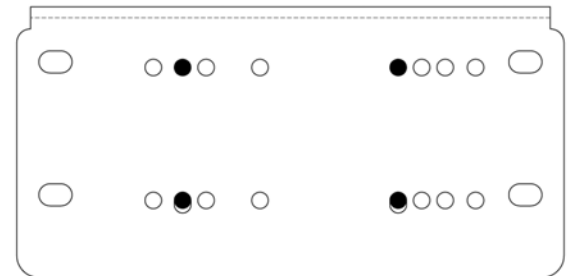

WARN 3.0
WARN RT25.30
WARN XT25.30

VENOM 3500/4000

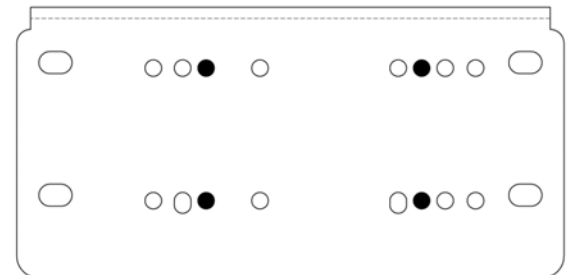

VENOM 3500X HARDCORE SERIES
VENOM 4000X HARDCORE SERIES

RH 2-HOLE WINCH

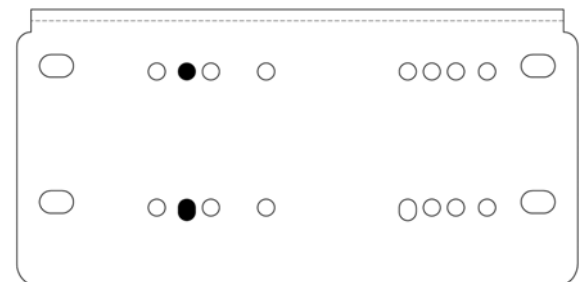

RIGHT-HAND MOTOR WINCH

LH 2-HOLE WINCH

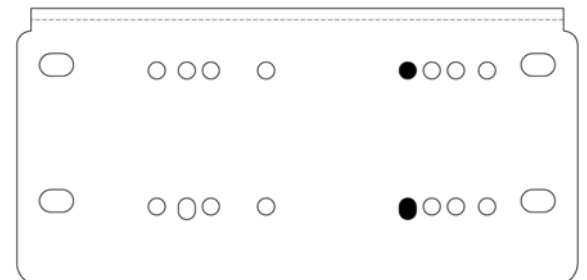

LEFT-HAND MOTOR WINCH